



# RF Power Field Effect Transistors

## N-Channel Enhancement-Mode Lateral MOSFETs

Designed for PCN and PCS base station applications with frequencies from 1900 to 2000 MHz. Suitable for TDMA, CDMA and multicarrier amplifier applications.

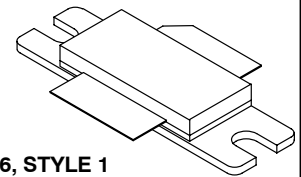
- Typical 2-Carrier N-CDMA Performance:  $V_{DD} = 28$  Volts,  $I_{DQ} = 1000$  mA,  $P_{out} = 22$  Watts Avg., Full Frequency Band. IS-95 (Pilot, Sync, Paging, Traffic Codes 8 Through 13) Channel Bandwidth = 1.2288 MHz. PAR = 9.8 dB @ 0.01% Probability on CCDF.
  - Power Gain — 13.9 dB
  - Drain Efficiency — 25.5%
  - IM3 @ 2.5 MHz Offset — -36.5 dBc in 1.2288 MHz Channel Bandwidth
  - ACPR @ 885 kHz Offset — -50.7 dBc in 30 kHz Channel Bandwidth
- Capable of Handling 10:1 VSWR, @ 28 Vdc, 1960 MHz, 100 Watts CW Output Power

### Features

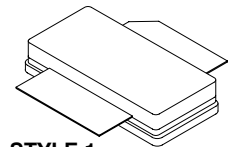
- Characterized with Series Equivalent Large-Signal Impedance Parameters
- Internally Matched for Ease of Use
- Qualified Up to a Maximum of 32  $V_{DD}$  Operation
- Integrated ESD Protection
- Lower Thermal Resistance Package
- Low Gold Plating Thickness on Leads, 40 $\mu$ m Nominal.
- RoHS Compliant
- In Tape and Reel. R3 Suffix = 250 Units per 56 mm, 13 Inch Reel.

**MRF5S19100HR3**  
**MRF5S19100HSR3**

**1930-1990 MHz, 22 W AVG., 28 V**  
**2 x N-CDMA**  
**LATERAL N-CHANNEL**  
**RF POWER MOSFETs**



**CASE 465-06, STYLE 1**  
**NI-780**  
**MRF5S19100HR3**



**CASE 465A-06, STYLE 1**  
**NI-780S**  
**MRF5S19100HSR3**

**Table 1. Maximum Ratings**

Rating	Symbol	Value	Unit
Drain-Source Voltage	$V_{DSS}$	-0.5, +65	Vdc
Gate-Source Voltage	$V_{GS}$	-0.5, +15	Vdc
Total Device Dissipation @ $T_C = 25^\circ\text{C}$ Derate above 25 $^\circ\text{C}$	$P_D$	269 1.54	W W/ $^\circ\text{C}$
Storage Temperature Range	$T_{stg}$	- 65 to +150	$^\circ\text{C}$
Case Operating Temperature	$T_C$	150	$^\circ\text{C}$
Operating Junction Temperature	$T_J$	200	$^\circ\text{C}$

**Table 2. Thermal Characteristics**

Characteristic	Symbol	Value <sup>(1)</sup>	Unit
Thermal Resistance, Junction to Case Case Temperature 75 $^\circ\text{C}$ , 100 W CW Case Temperature 70 $^\circ\text{C}$ , 22 W CW	$R_{\theta JC}$	0.64 0.65	$^\circ\text{C}/\text{W}$

1. Refer to AN1955, *Thermal Measurement Methodology of RF Power Amplifiers*. Go to <http://www.freescale.com/rf>.  
 Select Documentation/Application Notes - AN1955.

**Table 3. ESD Protection Characteristics**

Test Conditions	Class
Human Body Model	2 (Minimum)
Machine Model	M3 (Minimum)
Charge Device Model	C7 (Minimum)

**Table 4. Electrical Characteristics** ( $T_C = 25^\circ\text{C}$  unless otherwise noted)

Characteristic	Symbol	Min	Typ	Max	Unit
----------------	--------	-----	-----	-----	------

**Off Characteristics**

Zero Gate Voltage Drain Leakage Current ( $V_{DS} = 65\text{ Vdc}$ , $V_{GS} = 0\text{ Vdc}$ )	$I_{DSS}$	—	—	10	$\mu\text{Adc}$
Zero Gate Voltage Drain Leakage Current ( $V_{DS} = 28\text{ Vdc}$ , $V_{GS} = 0\text{ Vdc}$ )	$I_{DSS}$	—	—	1	$\mu\text{Adc}$
Gate-Source Leakage Current ( $V_{GS} = 5\text{ Vdc}$ , $V_{DS} = 0\text{ Vdc}$ )	$I_{GSS}$	—	—	1	$\mu\text{Adc}$

**On Characteristics (DC)**

Gate Threshold Voltage ( $V_{DS} = 10\text{ Vdc}$ , $I_D = 240\ \mu\text{Adc}$ )	$V_{GS(th)}$	—	2.7	—	Vdc
Gate Quiescent Voltage ( $V_{DS} = 28\text{ Vdc}$ , $I_D = 1000\text{ mAdc}$ )	$V_{GS(Q)}$	—	3.7	—	Vdc
Drain-Source On-Voltage ( $V_{GS} = 10\text{ Vdc}$ , $I_D = 2.4\text{ Adc}$ )	$V_{DS(on)}$	—	0.26	—	Vdc
Forward Transconductance ( $V_{DS} = 10\text{ Vdc}$ , $I_D = 2.4\text{ Adc}$ )	$g_{fs}$	—	6.3	—	S

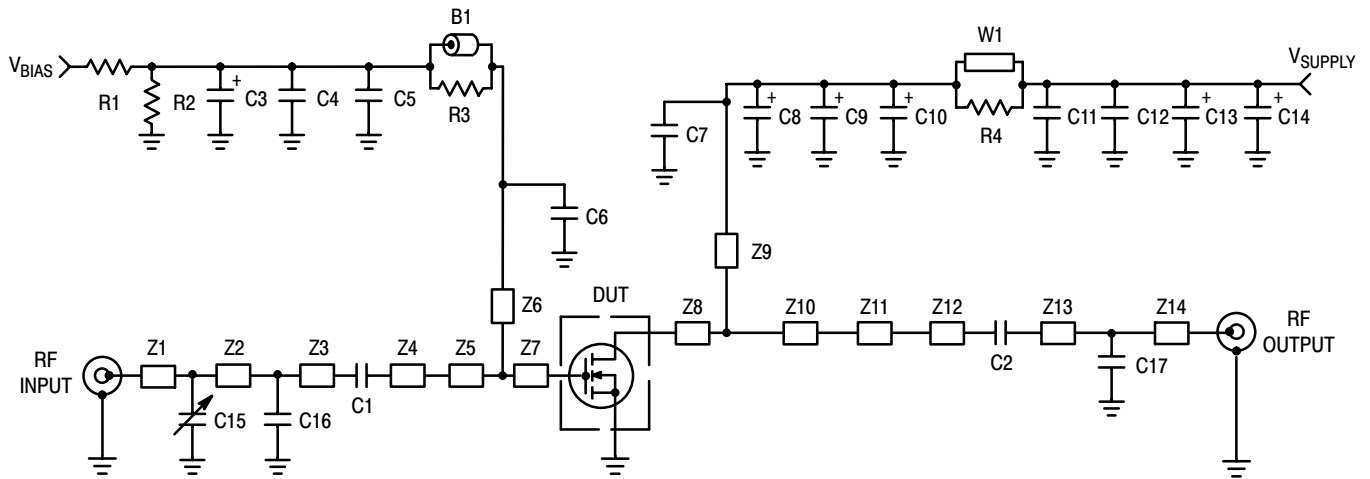
**Dynamic Characteristics**

Reverse Transfer Capacitance <sup>(1)</sup> ( $V_{DS} = 28\text{ Vdc}$ , $V_{GS} = 0$ , $f = 1.0\text{ MHz}$ )	$C_{rss}$	—	2.2	—	pF
-------------------------------------------------------------------------------------------------------------------	-----------	---	-----	---	----

**Functional Tests** (In Freescale Test Fixture, 50 ohm system)  $V_{DD} = 28\text{ Vdc}$ ,  $I_{DQ} = 1000\text{ mA}$ ,  $P_{out} = 22\text{ W Avg.}$ ,  $f_1 = 1930\text{ MHz}$ ,  $f_2 = 1932.5\text{ MHz}$  and  $f_1 = 1987.5\text{ MHz}$ ,  $f_2 = 1990\text{ MHz}$ , 2-Carrier N-CDMA, 1.2288 MHz Channel Bandwidth Carriers. ACPR measured in 30 kHz Bandwidth @  $\pm 885\text{ kHz}$  Offset. IM3 measured in 1.2288 MHz Channel Bandwidth @  $\pm 2.5\text{ MHz}$  Offset. PAR = 9.8 dB @ 0.01% Probability on CCDF.

Power Gain	$G_{ps}$	12.5	13.9	—	dB
Drain Efficiency	$\eta_D$	24	25.5	—	%
Intermodulation Distortion	IM3	—	-36.5	-35	dBc
Adjacent Channel Power Ratio	ACPR	—	-50.7	-48	dBc
Input Return Loss	IRL	—	-13	-9	dB

1. Part is internally matched both on input and output.



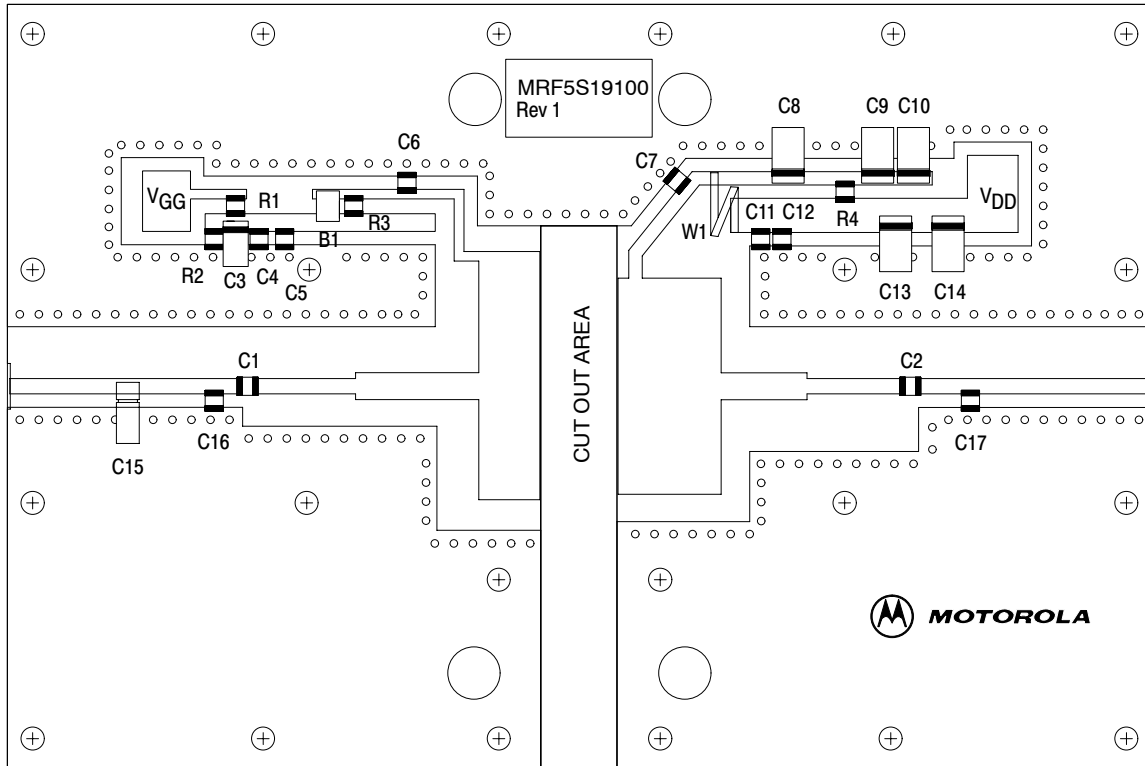
Z1, Z3	0.140" x 0.080" Microstrip	Z9	0.590" x 0.071" Microstrip
Z2	0.450" x 0.080" Microstrip	Z10	0.450" x 1.133" Microstrip
Z4	0.525" x 0.080" Microstrip	Z11	0.450" x 0.141" Microstrip
Z5	0.636" x 0.141" Microstrip	Z12	0.490" x 0.080" Microstrip
Z6	0.650" x 0.050" Microstrip	Z13	0.085" x 0.080" Microstrip
Z7	0.320" x 1.299" Microstrip	Z14	1.124" x 0.080" Microstrip
Z8	0.091" x 1.133" Microstrip	PCB	Arlon GX-0300-55-22, 0.030", $\epsilon_r = 2.55$

**Figure 1. MRF5S19100HR3(SR3) Test Circuit Schematic**

**Table 5. MRF5S19100HR3(SR3) Test Circuit Component Designations and Values**

Part	Description	Part Number	Manufacturer
B1	Short RF Bead	95F786	Newark
C1	22 pF Chip Capacitor	100B220CP 500X	ATC
C2	10 pF Chip Capacitor	100B100CP 500X	ATC
C3	1 $\mu$ F, 50 V Tantalum Capacitor	T494C105(1)050AS	Kemet
C4, C12	0.1 $\mu$ F Chip Capacitors	CDR33BX104AKWS	Kemet
C5, C11	1K pF Chip Capacitors	100B102JP 500X	ATC
C6	2.7 pF Chip Capacitor	100B2R7BP 500X	ATC
C7	4.3 pF Chip Capacitor	100B4R3JP 500X	ATC
C8	10 $\mu$ F, 35 V Tantalum Capacitor	T494D106(1)035AS	Kemet
C9, C10, C13, C14	22 $\mu$ F, 35 V Tantalum Capacitors	T494X226(1)035AS	Kemet
C15	0.6 – 4.5 Gigatrim Variable Capacitor	44F3358	Newark
C16	2.2 pF Chip Capacitor	100B2R2BP 500X	ATC
C17*	0.3 pF Chip Capacitor	100B0R3BP 500X	ATC
R1	1 k $\Omega$ Chip Resistor	D5534M07B1K00R	Newark
R2	560 k $\Omega$ Chip Resistor	CR1206 564JT	Newark
R3, R4	12 $\Omega$ Chip Resistors	RM73B2B120JT	Garrett Electronics
W1	1 turn 14 gauge wire		

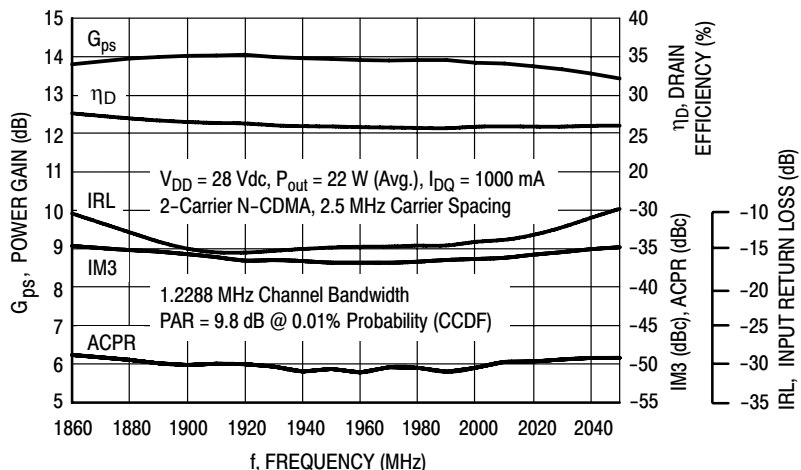
\* Need for part will vary from fixture to fixture.



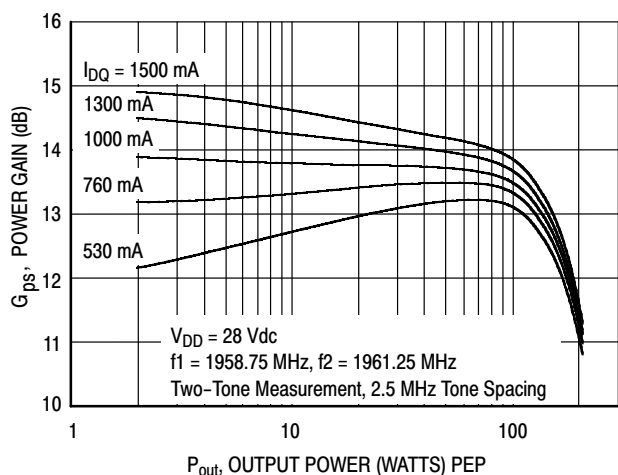
Freescall has begun the transition of marking Printed Circuit Boards (PCBs) with the Freescall Semiconductor signature/logo. PCBs may have either Motorola or Freescall markings during the transition period. These changes will have no impact on form, fit or function of the current product.

**Figure 2. MRF5S19100HR3(SR3) Test Circuit Component Layout**

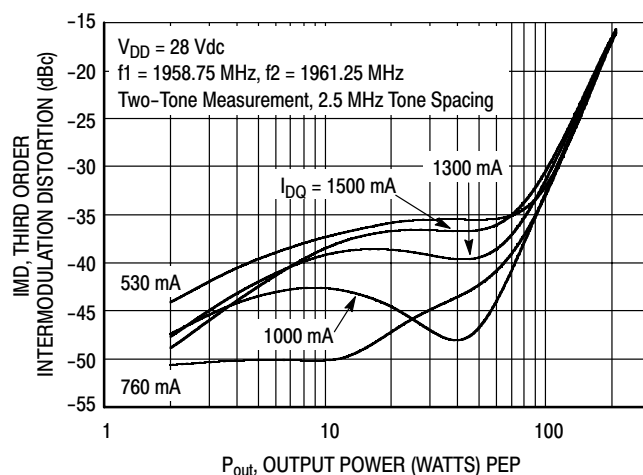
## TYPICAL CHARACTERISTICS



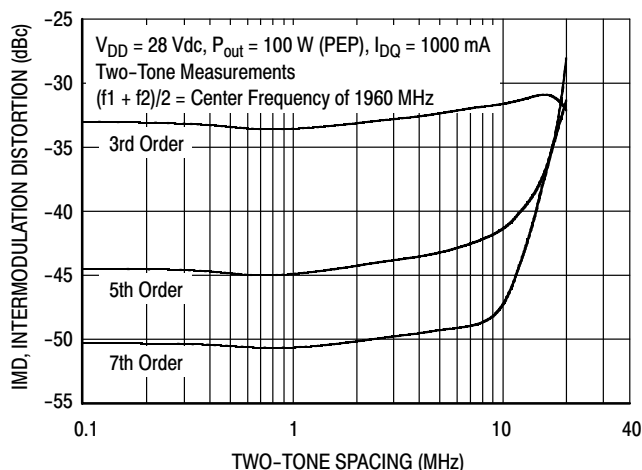
**Figure 3. 2-Carrier N-CDMA Broadband Performance**



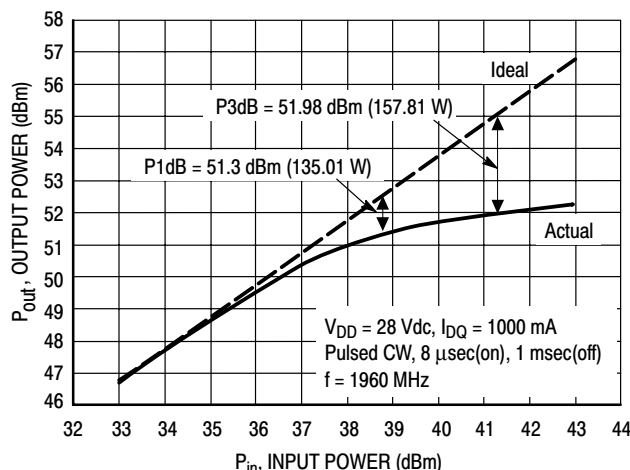
**Figure 4. Two-Tone Power Gain versus Output Power**



**Figure 5. Third Order Intermodulation Distortion versus Output Power**

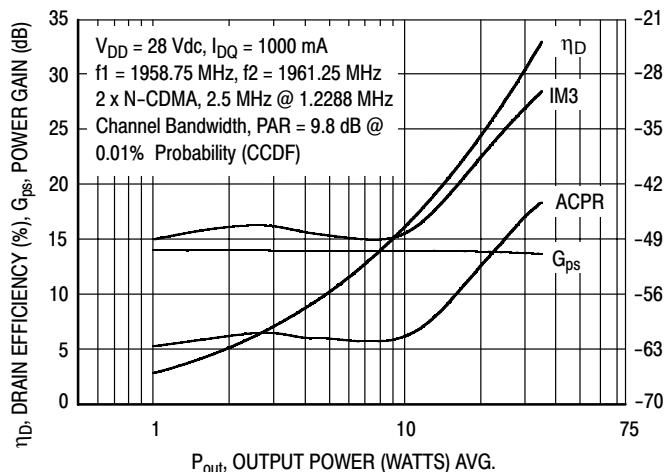


**Figure 6. Intermodulation Distortion Products versus Tone Spacing**

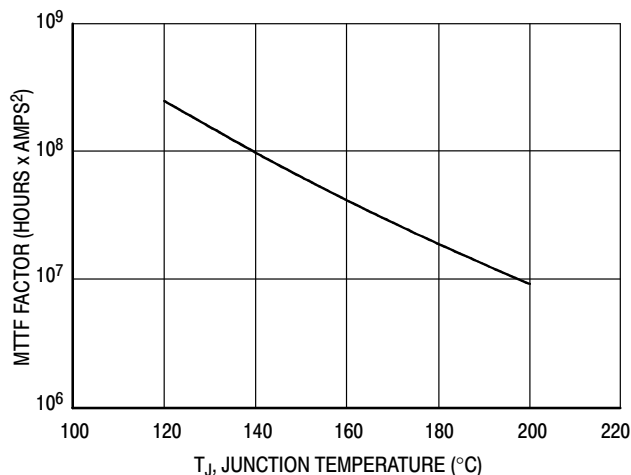


**Figure 7. Pulse CW Output Power versus Input Power**

## TYPICAL CHARACTERISTICS



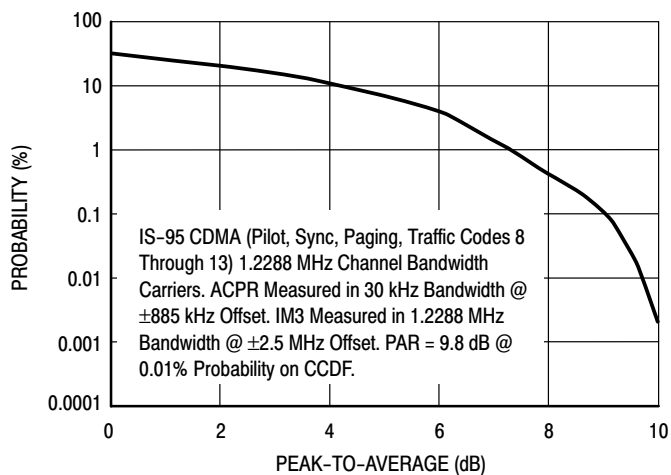
**Figure 8. 2-Carrier N-CDMA ACPR, IM3, Power Gain and Drain Efficiency versus Output Power**



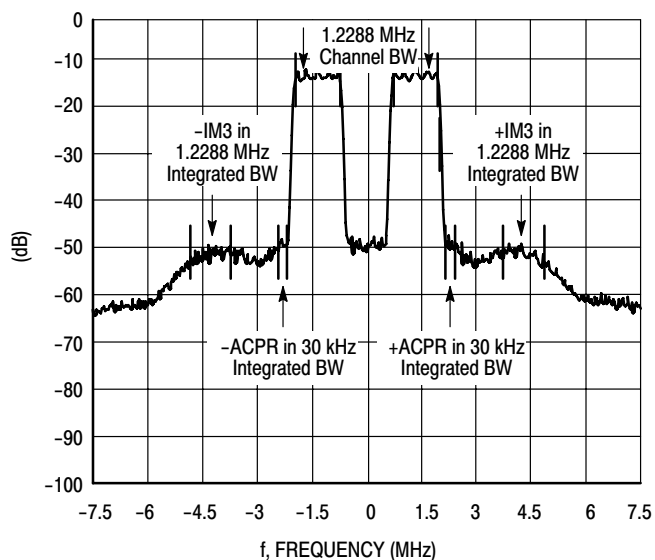
This above graph displays calculated MTTF in hours x ampere<sup>2</sup> drain current. Life tests at elevated temperatures have correlated to better than  $\pm 10\%$  of the theoretical prediction for metal failure. Divide MTTF factor by  $I_D^2$  for MTTF in a particular application.

**Figure 9. MTTF Factor versus Junction Temperature**

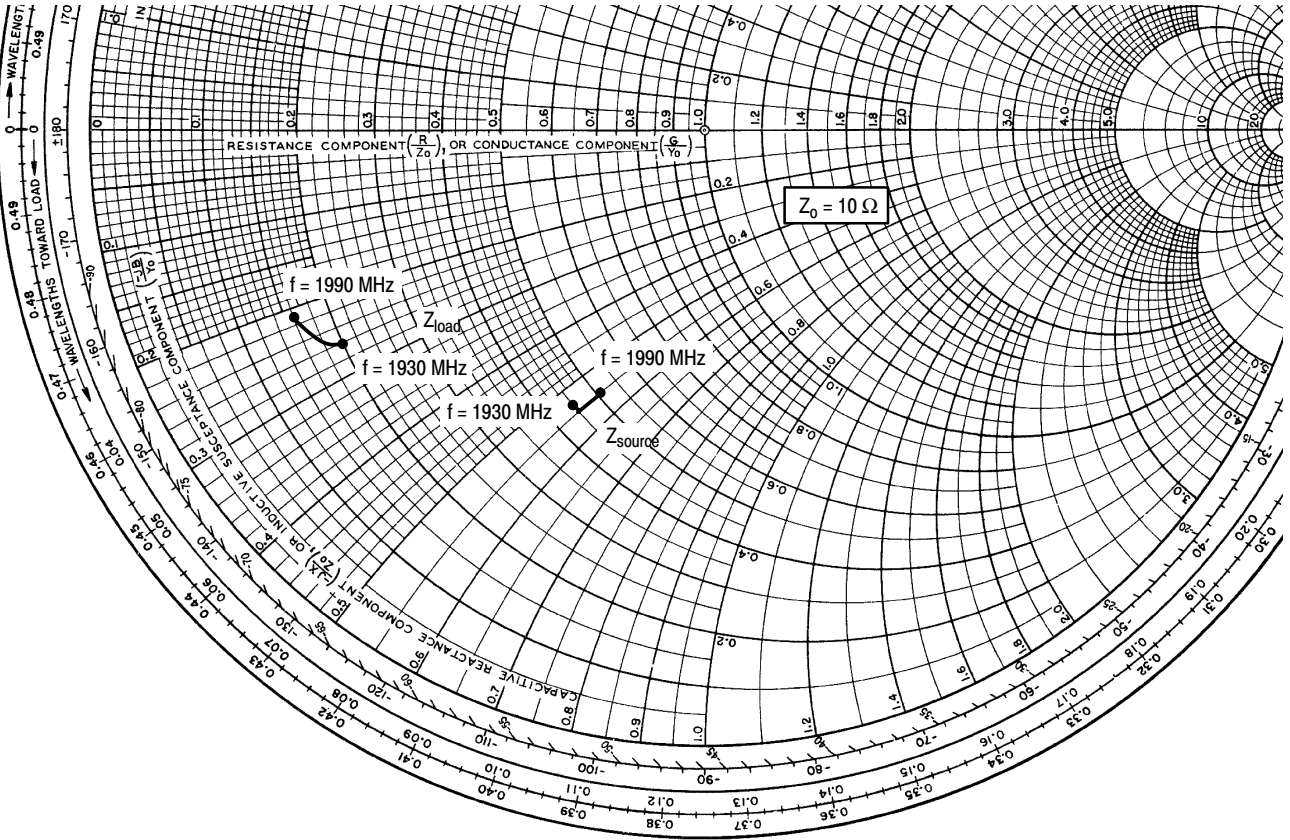
## N-CDMA TEST SIGNAL



**Figure 10. 2-Carrier CCDF N-CDMA**



**Figure 11. 2-Carrier N-CDMA Spectrum**



$V_{DD} = 28 \text{ Vdc}$ ,  $I_{DQ} = 1000 \text{ mA}$ ,  $P_{out} = 22 \text{ W Avg.}$

f MHz	$Z_{source}$ $\Omega$	$Z_{load}$ $\Omega$
1930	4.45 - j5.32	1.98 - j2.58
1960	4.53 - j5.40	1.83 - j2.55
1990	5.12 - j5.45	1.60 - j2.15

$Z_{source}$  = Test circuit impedance as measured from gate to ground.

$Z_{load}$  = Test circuit impedance as measured from drain to ground.

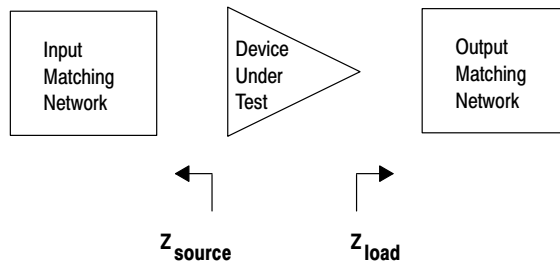


Figure 12. Series Equivalent Source and Load Impedance

# NOTES

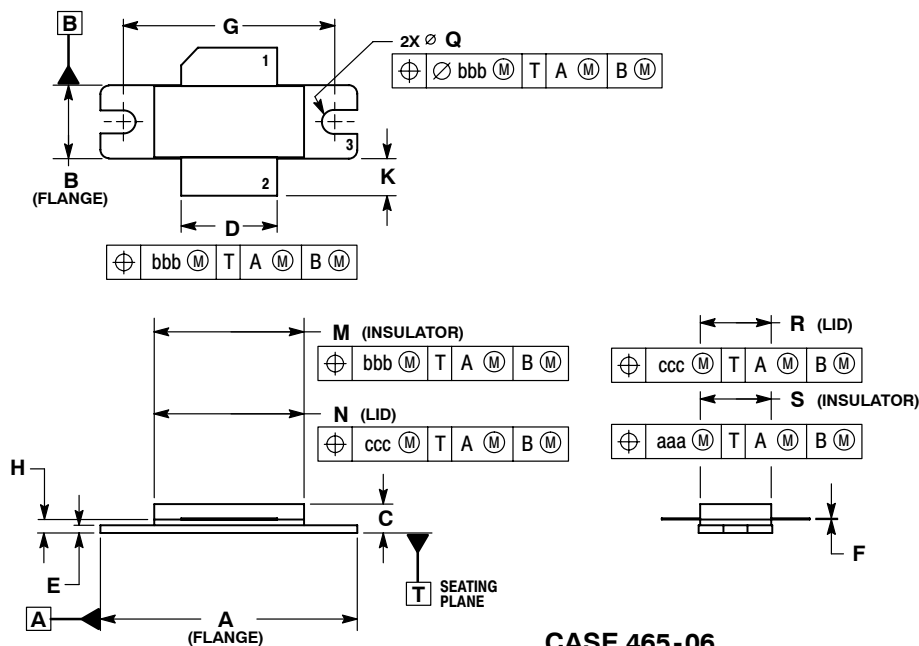


---

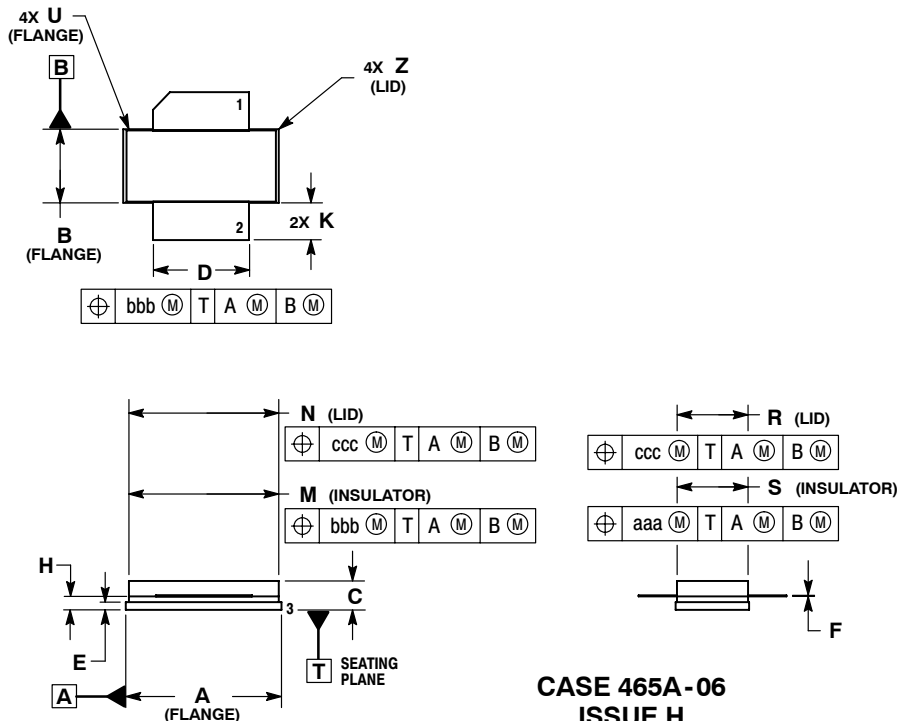
# NOTES

# NOTES

## PACKAGE DIMENSIONS



**CASE 465-06  
 ISSUE G  
 NI-780  
 MRF5S19100HR3**



**CASE 465A-06  
 ISSUE H  
 NI-780S  
 MRF5S19100HSR3**

**MRF5S19100HR3 MRF5S19100HSR3**

## **How to Reach Us:**

### **Home Page:**

www.freescale.com

### **E-mail:**

support@freescale.com

### **USA/Europe or Locations Not Listed:**

Freescale Semiconductor  
Technical Information Center, CH370  
1300 N. Alma School Road  
Chandler, Arizona 85224  
+1-800-521-6274 or +1-480-768-2130  
support@freescale.com

### **Europe, Middle East, and Africa:**

Freescale Halbleiter Deutschland GmbH  
Technical Information Center  
Schatzbogen 7  
81829 Muenchen, Germany  
+44 1296 380 456 (English)  
+46 8 52200080 (English)  
+49 89 92103 559 (German)  
+33 1 69 35 48 48 (French)  
support@freescale.com

### **Japan:**

Freescale Semiconductor Japan Ltd.  
Headquarters  
ARCO Tower 15F  
1-8-1, Shimo-Meguro, Meguro-ku,  
Tokyo 153-0064  
Japan  
0120 191014 or +81 3 5437 9125  
support.japan@freescale.com

### **Asia/Pacific:**

Freescale Semiconductor Hong Kong Ltd.  
Technical Information Center  
2 Dai King Street  
Tai Po Industrial Estate  
Tai Po, N.T., Hong Kong  
+800 2666 8080  
support.asia@freescale.com

### **For Literature Requests Only:**

Freescale Semiconductor Literature Distribution Center  
P.O. Box 5405  
Denver, Colorado 80217  
1-800-441-2447 or 303-675-2140  
Fax: 303-675-2150  
LDCForFreescaleSemiconductor@hibbertgroup.com

Information in this document is provided solely to enable system and software implementers to use Freescale Semiconductor products. There are no express or implied copyright licenses granted hereunder to design or fabricate any integrated circuits or integrated circuits based on the information in this document.

Freescale Semiconductor reserves the right to make changes without further notice to any products herein. Freescale Semiconductor makes no warranty, representation or guarantee regarding the suitability of its products for any particular purpose, nor does Freescale Semiconductor assume any liability arising out of the application or use of any product or circuit, and specifically disclaims any and all liability, including without limitation consequential or incidental damages. "Typical" parameters that may be provided in Freescale Semiconductor data sheets and/or specifications can and do vary in different applications and actual performance may vary over time. All operating parameters, including "Typicals", must be validated for each customer application by customer's technical experts. Freescale Semiconductor does not convey any license under its patent rights nor the rights of others. Freescale Semiconductor products are not designed, intended, or authorized for use as components in systems intended for surgical implant into the body, or other applications intended to support or sustain life, or for any other application in which the failure of the Freescale Semiconductor product could create a situation where personal injury or death may occur. Should Buyer purchase or use Freescale Semiconductor products for any such unintended or unauthorized application, Buyer shall indemnify and hold Freescale Semiconductor and its officers, employees, subsidiaries, affiliates, and distributors harmless against all claims, costs, damages, and expenses, and reasonable attorney fees arising out of, directly or indirectly, any claim of personal injury or death associated with such unintended or unauthorized use, even if such claim alleges that Freescale Semiconductor was negligent regarding the design or manufacture of the part.

Freescale™ and the Freescale logo are trademarks of Freescale Semiconductor, Inc. All other product or service names are the property of their respective owners.  
© Freescale Semiconductor, Inc. 2006. All rights reserved.

